

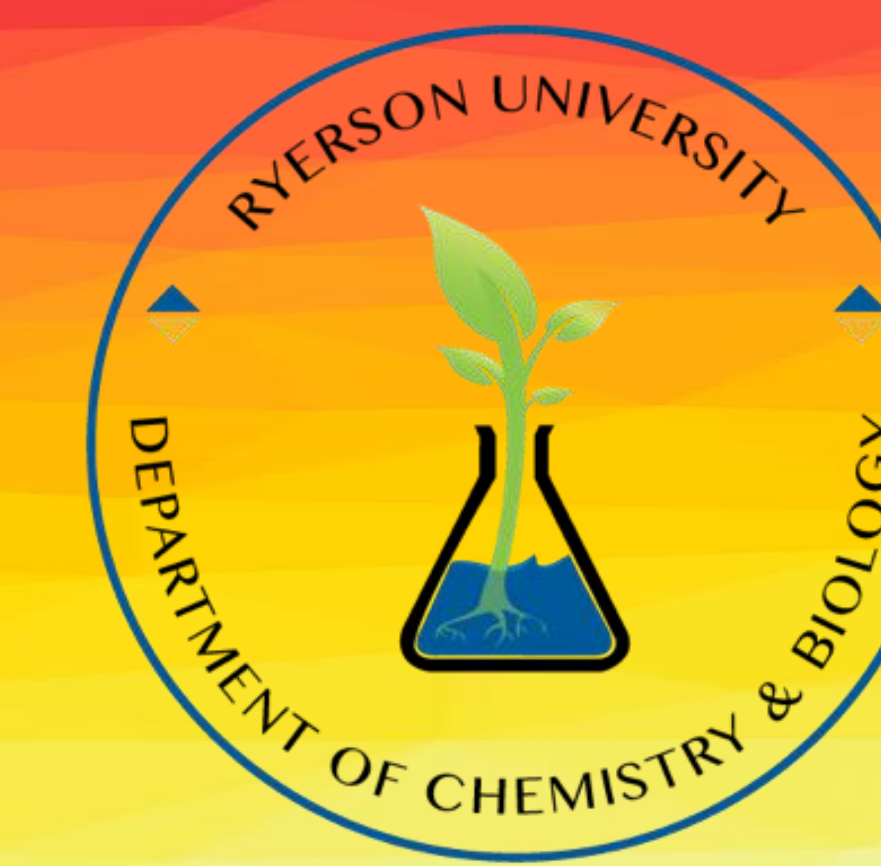

# Digital Processing with a Hybrid Plasmonic Logic Nanogate

Laraa Al Nubani, Nicholas Dogantzis, Gregory Hodgson, Stefania Impellizzeri\*

Ryerson University, Department of Chemistry & Biology



## ABSTRACT

We developed a simple strategy to gate a plasmonic event with a hybrid photoresponsive compound capable of mimicking AND-type logic behaviour. Binary digits are encoded into ultraviolet and visible illumination (which are used as inputs) and the fluorescence of the molecule (the arithmetic output). The plasmonic process chosen is the visible light-controlled, gold-nanoparticle (AuNP) catalysed reduction of resazurin to resorufin, while the second optical input is the UVA-induced cleavage of a 2-nitrobenzyl quencher. The synergistic combination of plasmonic nanostructures and organic molecules allows for the manipulation of a programmable Boolean logic operation at the molecular level.

## AuNP SYNTHESIS

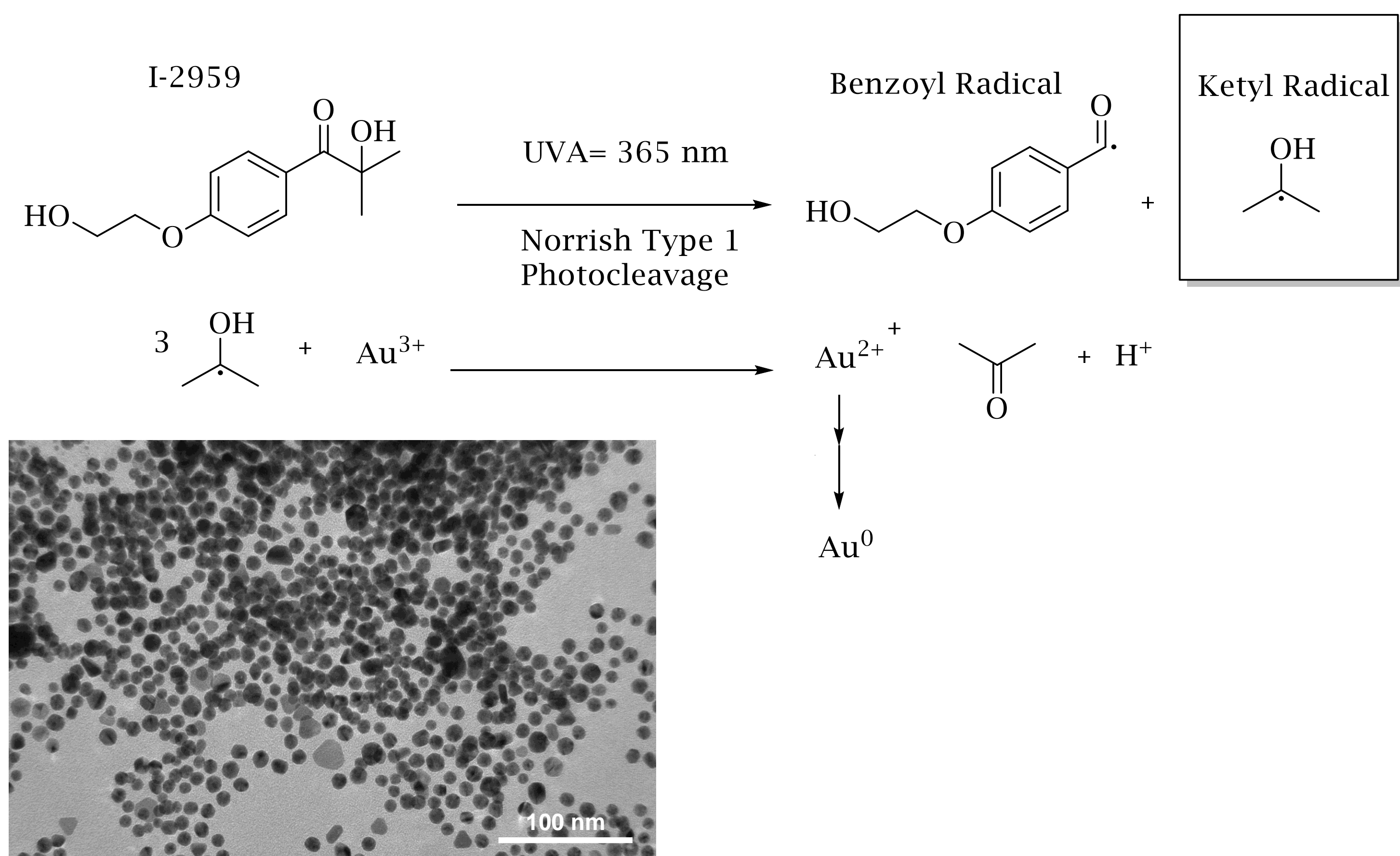

## SYNTHESIS OF PHOTOCAGED COMPOUNDS

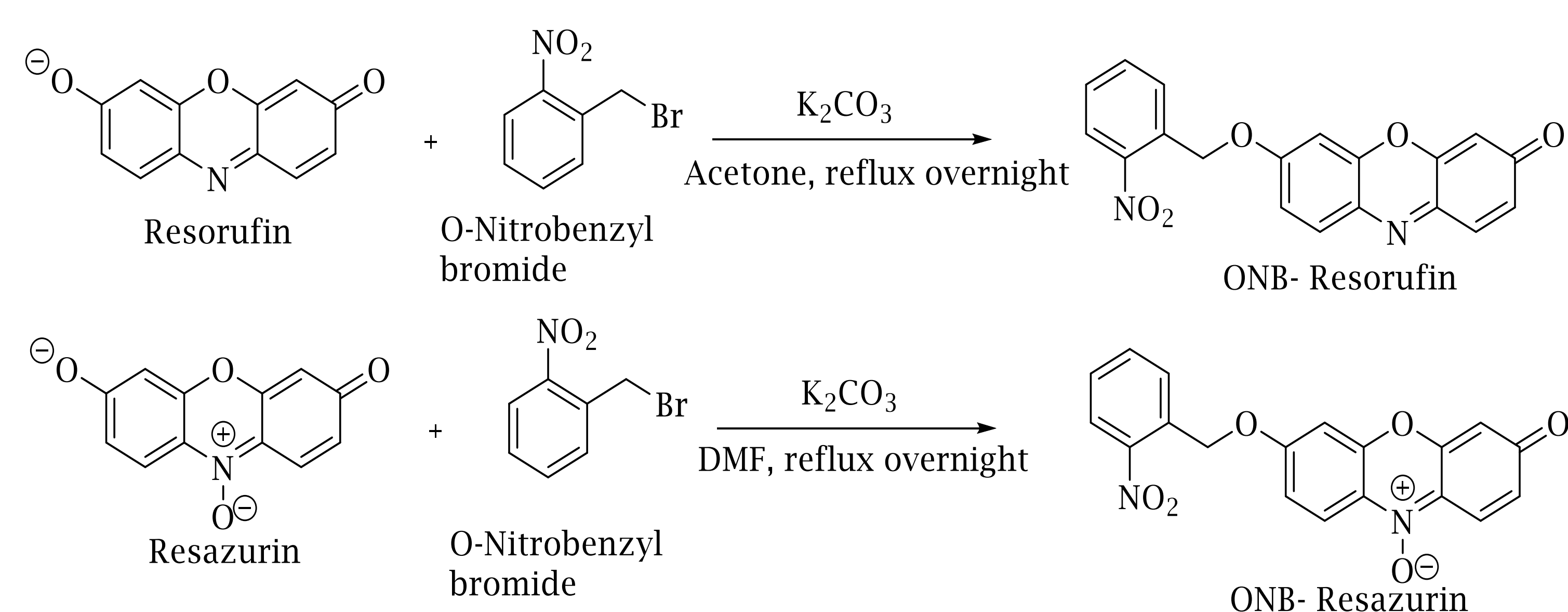

## PROJECT GOAL

### Transducing Logic Gate Behaviour to the Molecular Level using a Photoresponsive Compound and Photochemical Inputs

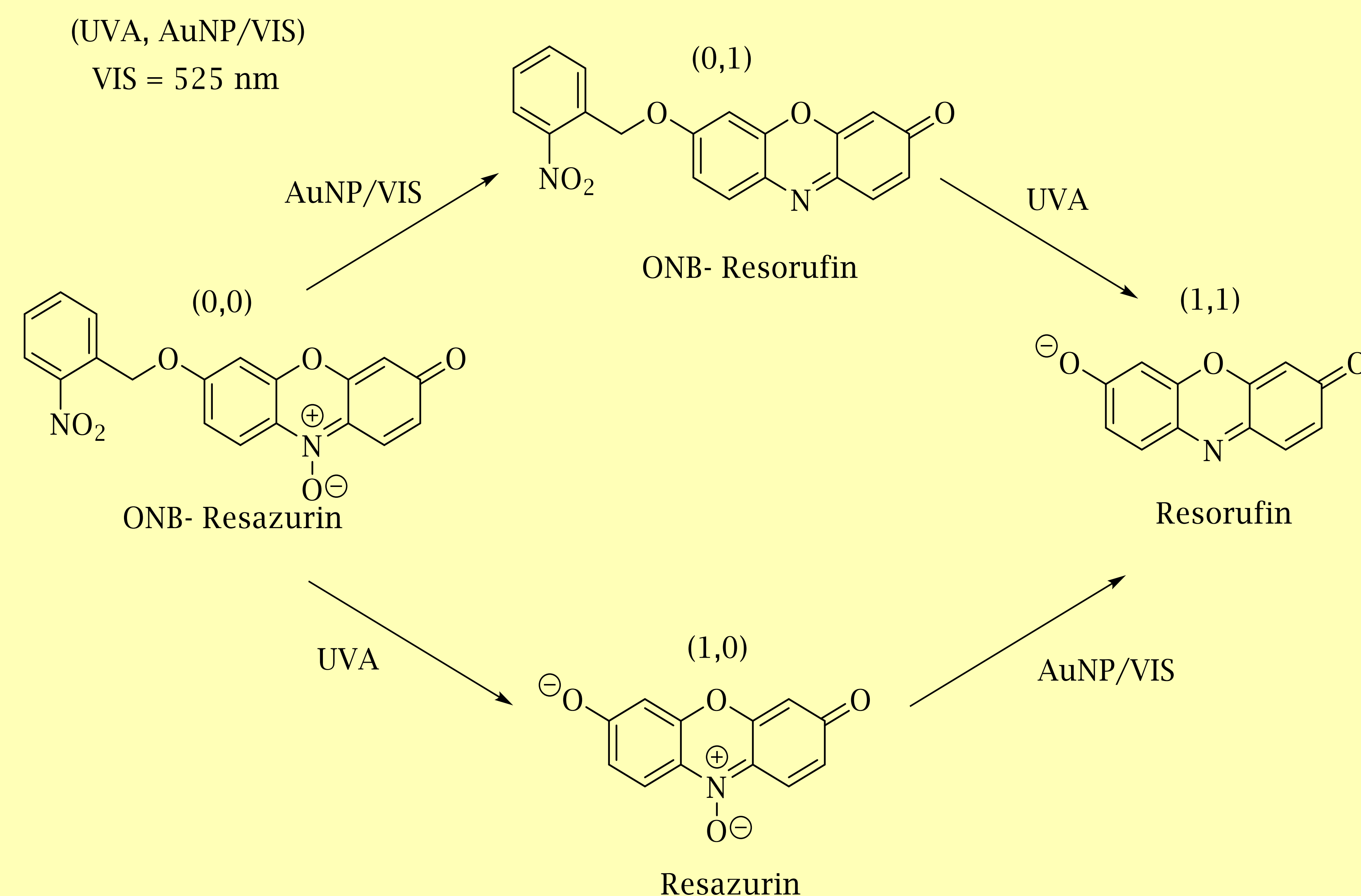

| I <sub>1</sub> (UVA) | I <sub>2</sub> (Vis) | OUTPUT (Fluorescence) |
|----------------------|----------------------|-----------------------|
| 0                    | 0                    | 0                     |
| 1                    | 0                    | 0                     |
| 0                    | 1                    | 0                     |
| 1                    | 1                    | 1                     |

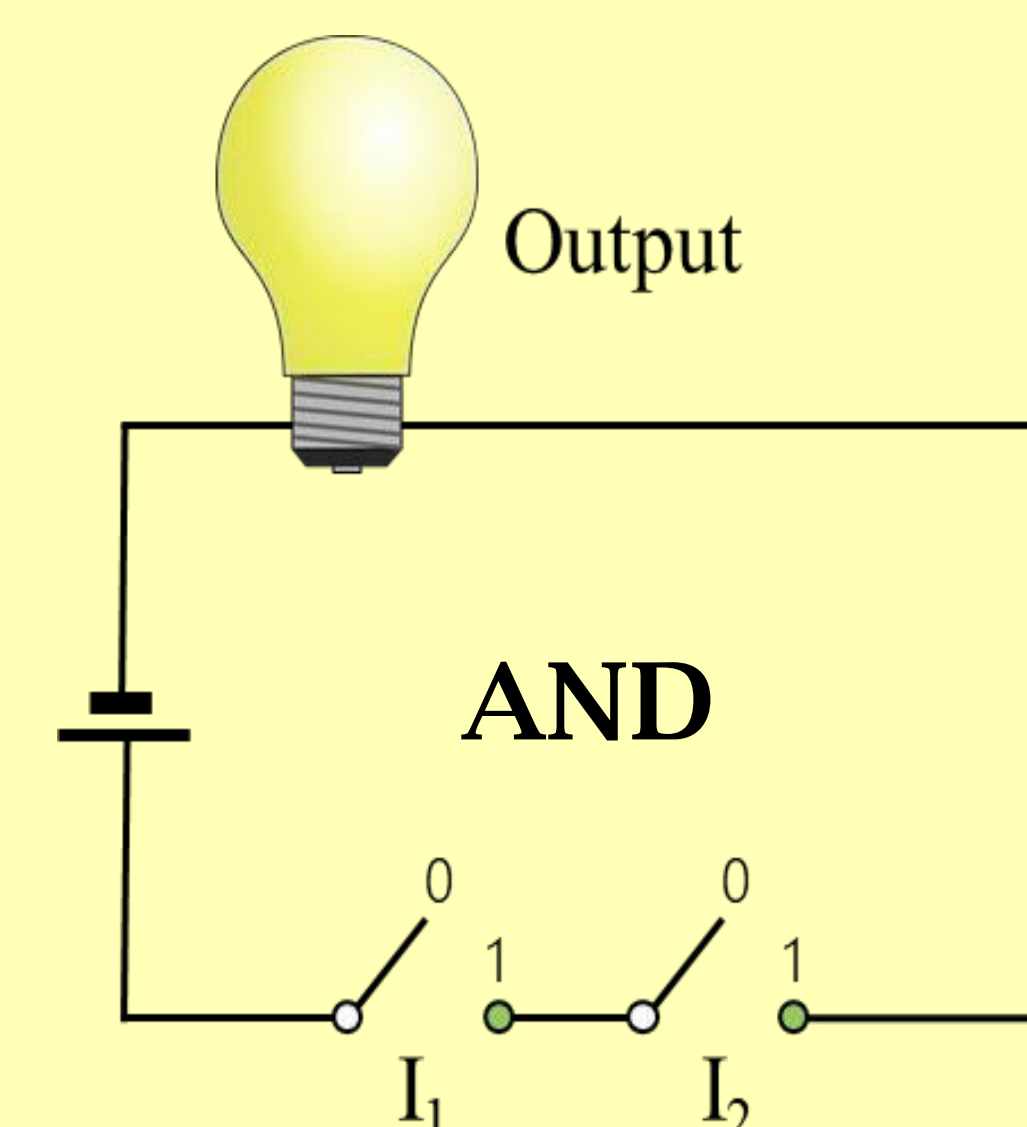
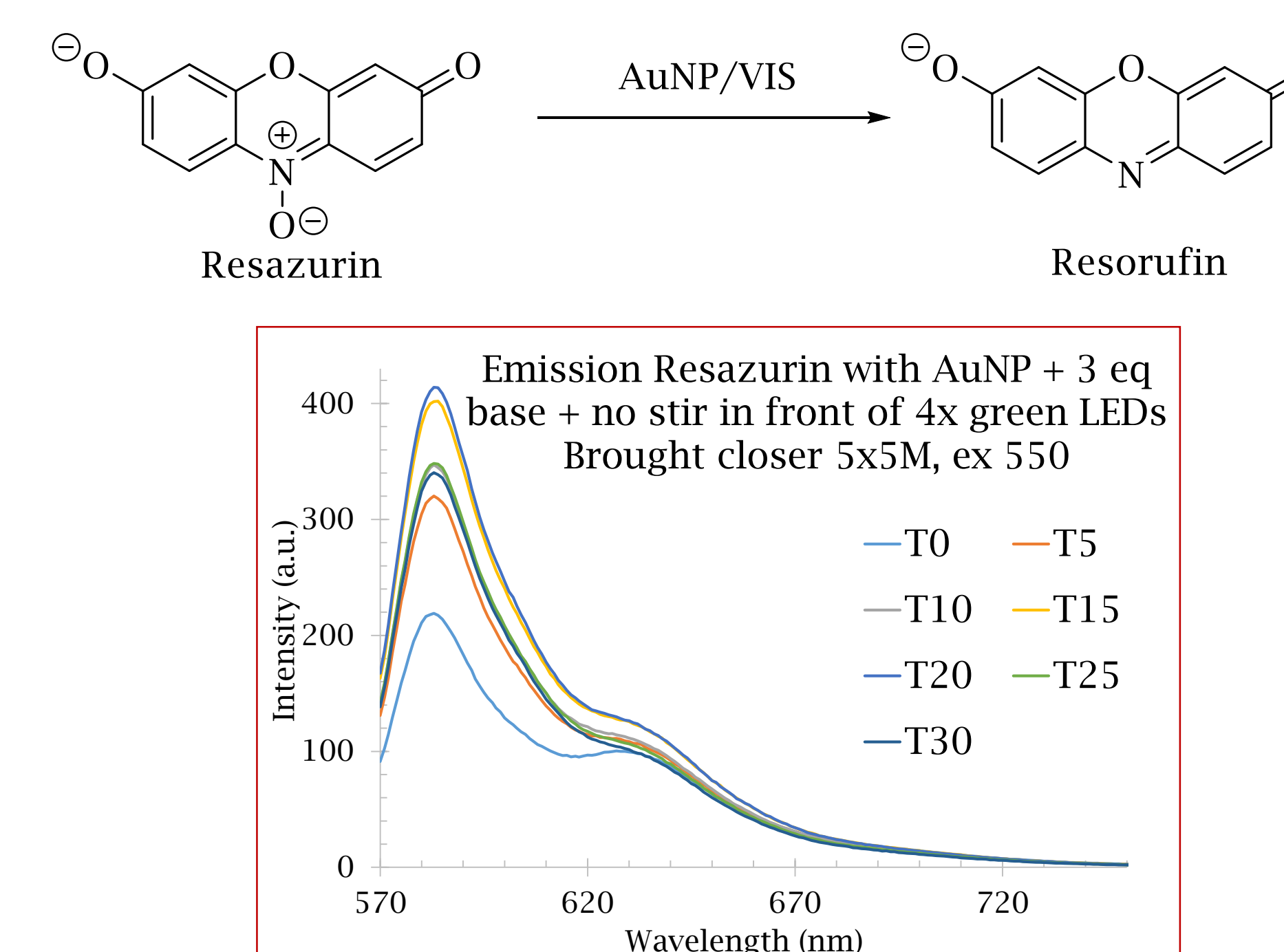
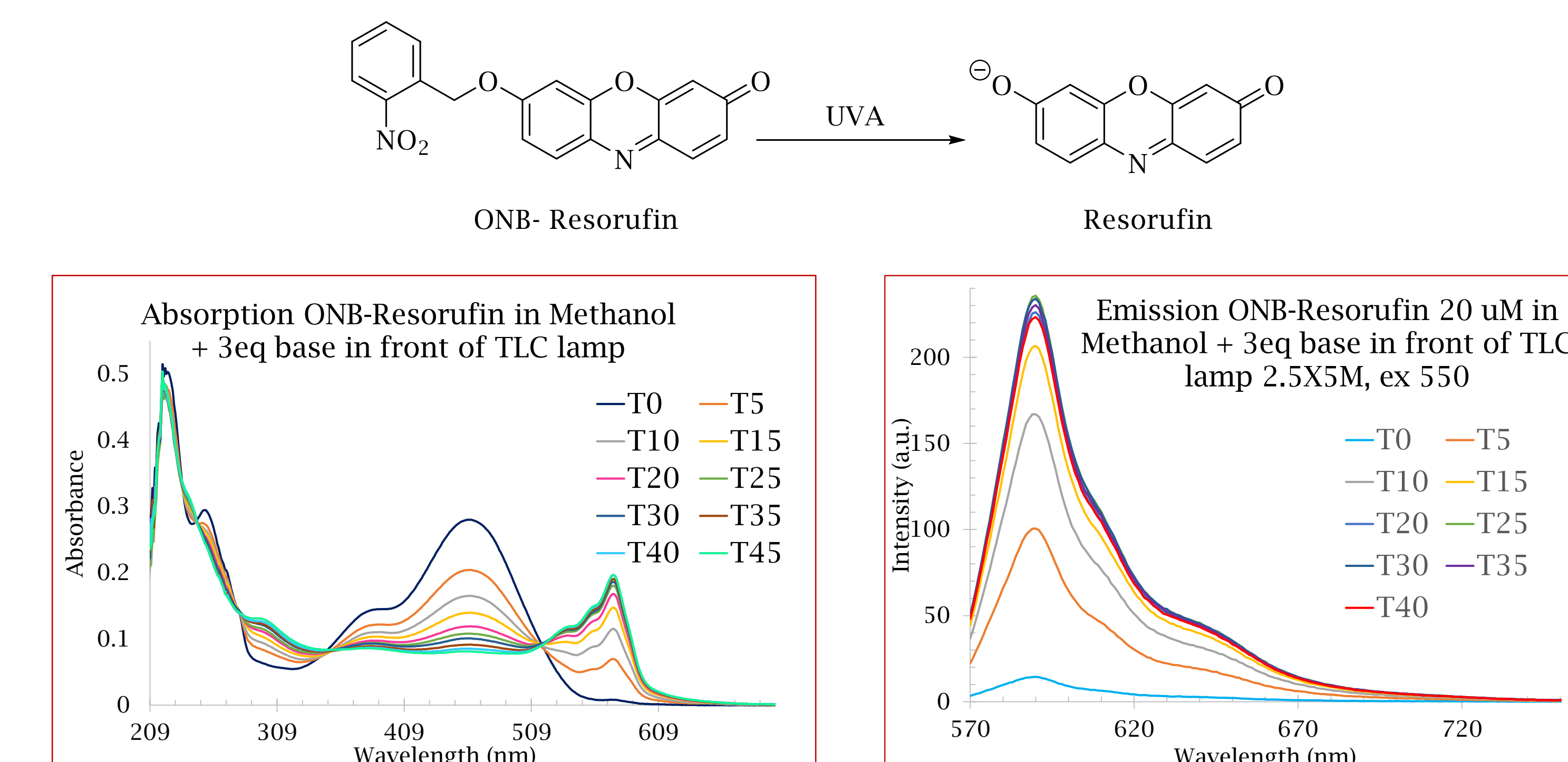

Table 1. Truth table and circuit of the AND logic gate.

## RESULTS



## REFERENCES

Mcgilvray, K. L.; Decan, M. R.; Wang, D.; Scaiano, J. C. *Journal of the American Chemical Society* **2006**, *128*, 15980.

Alejo, C. J. B.; Fasciani, C.; Grenier, M.; Netto-Ferreira, J. C.; Scaiano, J. C. *Catalysis Science & Technology* **2011**, *1*, 1506.

## ACKNOWLEDGMENTS

The Undergraduate Research Opportunities (URO) Program  
Lana Al Nubani, Wesam A., Zainab Shakeel and Melissa D'Amara  
The members of Drs. Foucher, Gossage and McWilliams Lab  
All members of the Impellizzeri Group:



Ryerson University

